



The BMS-S823-PIR-1-BLE-SR-ZMO occupancy sensor uses PIR Motion Detector, Architecture and passive infrared (PIR) technology for improved detection coverage for ceiling or fixture mount, high bay, and low bay applications.

OVERVIEW

- PIR sensor.
- Bluetooth® SIG mesh.
- High-End Trim, Zoning, Continuous Bi-level Dimming.
- LED Motion indicator.
- Mounting height up to 40 ft .
- 360° coverage pattern.
- Line Voltage connector.

FEATURES AND BENEFITS

- Bluetooth to 0-10V signal converter, Bluetooth® mesh network.
- Built-in 25mA 0-10V signal output.
- Mesh network, which has a much longer control distance, transmits received signals to neighboring devices.
- In typical outdoor environment, the typical range for wireless communication is 328ft(100m).
- Actual range is dependent on site conditions.
- Available with Magnetic reset (Touch the top part of sensor for 5 seconds).
- On-board antenna.

TECHNICAL DATA

Motion Sensor	Passive Infrared (PIR)
Input Power	120/277VAC 50/60Hz
Control Output	0-10V,max 25mA sinking current
Maximum Load	Resistive/Halogen - 800W@120V/1200W@277V Fluorescent Ballast - 660W@120V/1200W@277V Electronic Ballast (LED/CFL) - 5A@120V/5A@277V
Detection angle	360°
Low Bay Lens	Max.detection radius 30ft; Max.mounting height 8ft
High Bay Lens	Max.detection radius 30ft; Max.mounting height 40ft
Operating temperature	-40°F ~ +158°F (-40°C ~ +70°C)
Max Bluetooth Range	328ft(100m)
IP Rating	IP65

PHYSICAL DIMENSIONS

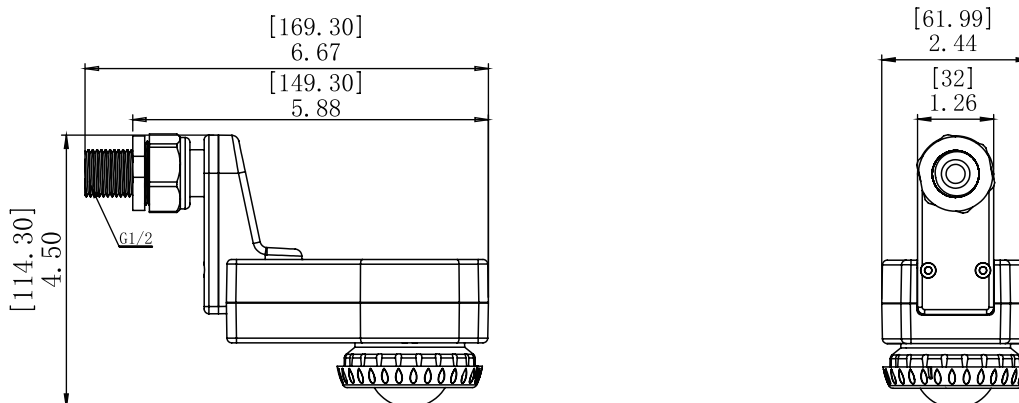

ORDERING INFORMATION

Model No.	Description	Input Voltage	Output	Mount
BMS-S823-PIR-1-BLE-SR-ZMO	Passive Infrared (PIR) Occupancy Sensor with Bluetooth Mesh Feature	120/277VAC	0-10V	Z Shaped Side Mount With Enclosure for IP65
Add Suffix for Options	Description			
LS02-HB3-WH	360° High Bay Lens, Max.detection radius 30ft; Max.mounting height 40ft, white color			
LS02-LB4-WH	360° Low Bay Lens, Max.detection radius 30ft; Max.mounting height 8ft, white color			

DETECTION AREA

HB3 LENS



Coverage Side View

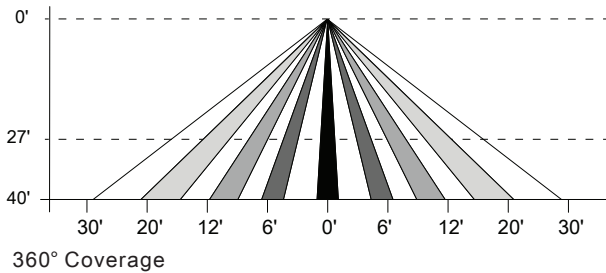

Coverage Top View

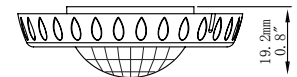
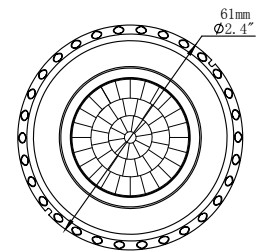
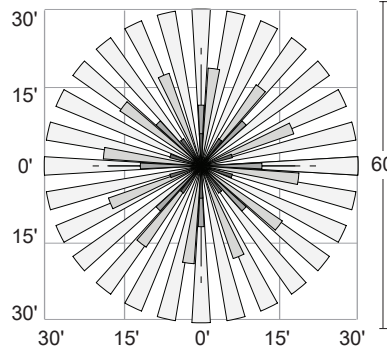

LB4 LENS



Coverage Side View

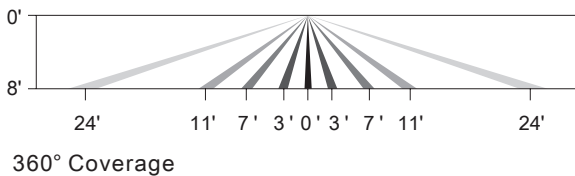

Coverage Top View

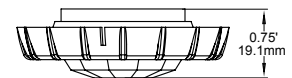
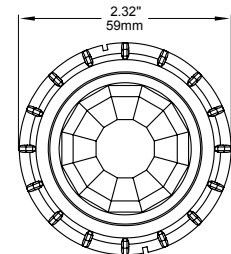
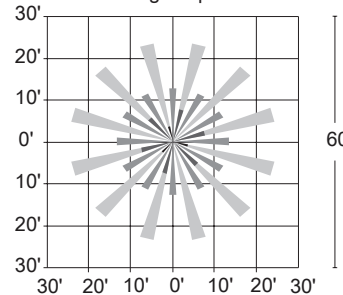

WIRING DIAGRAM

Ref#: 20240627

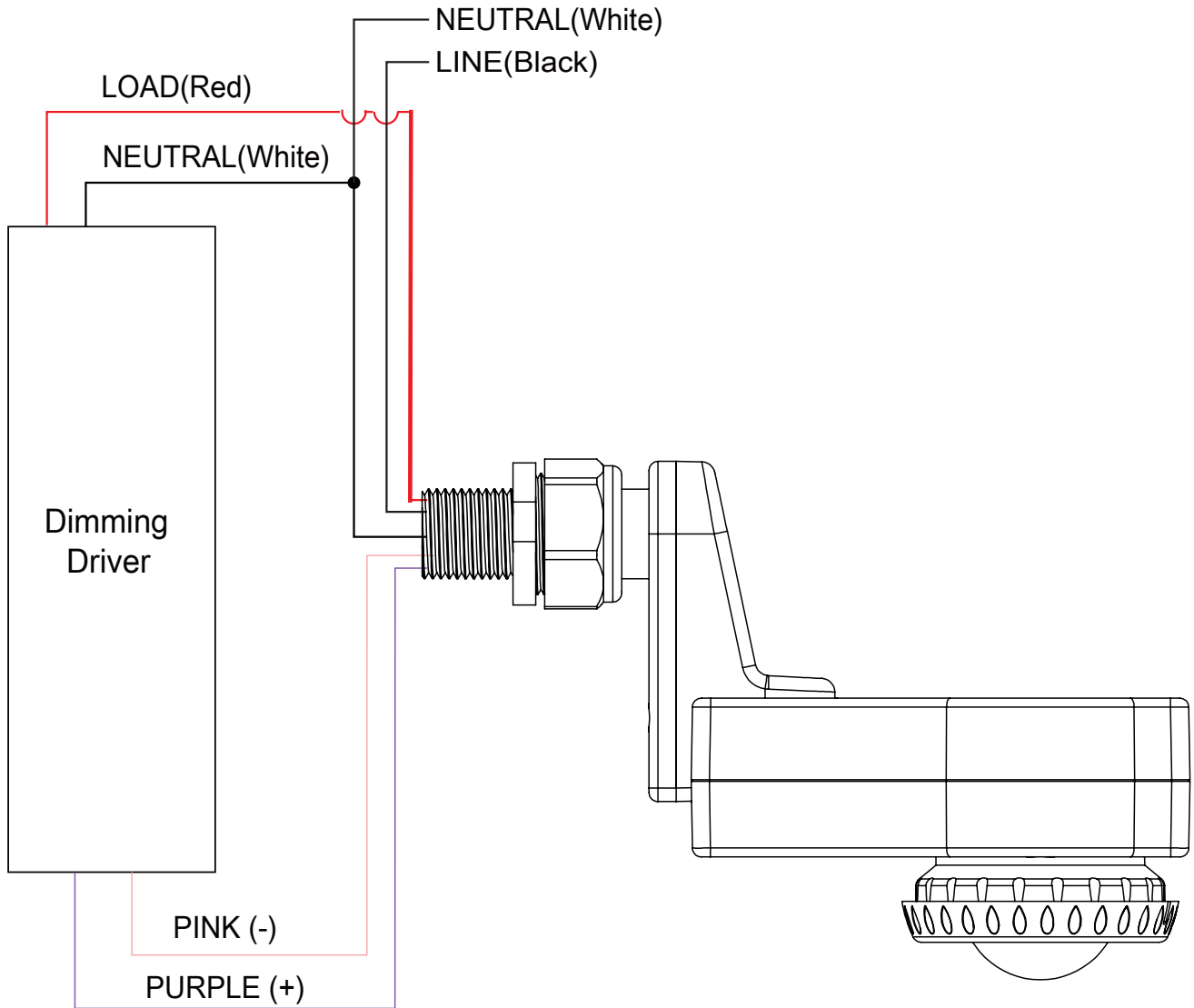

WARRANTY

Five year limited warranty.

Specifications subject to change without notice.